

















Ledklok PHB2 is de referentie voor het verlichten van industriële ruimten of magazijnen. PHB2 is voorzien van een IP65 behuizing met geïntegreerde ventilatiesleuven voor een optimale koelin en uitgerust met performante SMD3030 leds en een dimbare 1-10V kwaliteitsdriver met lange levensduur. PHB2 is standaard voorzien van een mat polycarbonaat cover. Toestelrendement tot 130lm/W bij 4000K, standaard lichtbundel van 110°. Met de optionele muurbeugel is het mogelijk om het toestel in een vaste positie te monteren op wand of plafond. Mogelijke opties : dimbaar DALI, muurbeugel, valbeveiliging, transparante 60 of 90° lens.

														
IP65	IK08	110	5	tot 130	0,99	70.000 L80B10	JA	>80	4000	1-10V	EMC3030	34	JA	NEE

### Technische eigenschappen

Referentie	PHB22004
EAN code	5420076269081
ETIM code	EC001716

### Elektrische eigenschappen

Systeem vermogen (W)	202,93
LED vermogen (W)	200,9
Aansluitspanning (Vac)	200-240
Frequentie (Hz)	47-63
Driver inbegrepen	ja
Driver intern/extern	intern
Driver merk	TCL
Driver type	200R
Dimbaar	1-10V
Flicker free	ja
Power factor	0,99
THD	<15%
Driver output (V)	
Driver output (mA)	
Isolatieklasse	I
Energie klasse	E
Aantal op 16A B curve	
Aantal op 16A C curve	6
Aantal op 16A D curve	9
Inrush current driver	62A

### Garantie en certificatie

ENEC	ja
Garantie (jaar)	5 (exclusief batterijen)

### Lichttechnische eigenschappen

Lichtbundel(°)	110
Kleurtemperatuur (K)	4000
Kleurweergave CRI	>80
UGR	34
Kleurvastheid SDCM	<5
Lumen output (Lm)	27618
Lm/W	130
Flux code	
Ledchip	EMC3030
Ledfabrikant	Tiandian
Aantal LEDs	336
Fotobiologische klasse	RG1

### Afmeting en materiaal eigenschappen

Afmetingen (LxBxH)	320x320x188mm
Gewicht (kg)	4,3
Kleur	zwart
Werktemperatuur (°C)	-30~+45
IP waarde	IP65
IK waarde	IK08
UV bestendig	ja
Zeewater bestendig	nee
UL 94	
Aantal in bulk	1
Aantal op pallet	42
Minimum bestelaantal	1
Stockartikel	nee

## PHB22004 - Ledklok PHB2 200W 4000K IP65 1-10V

### Lumen distribution

LUMINOUS INTENSITY DISTRIBUTION DIAGRAM

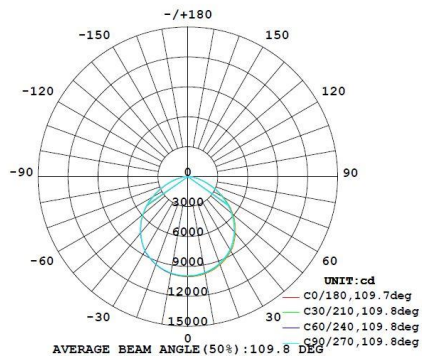

### Distance curve:

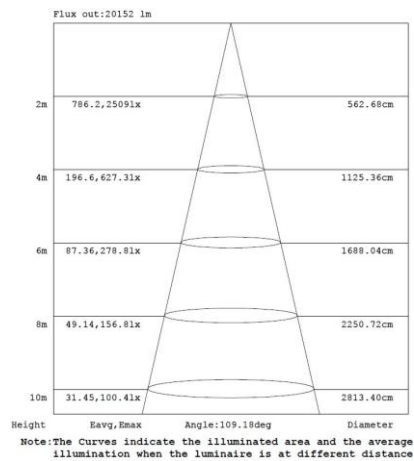



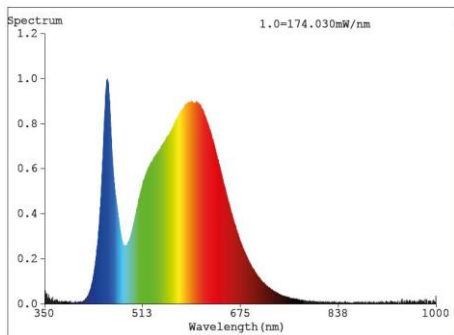

### Spectrum distribution

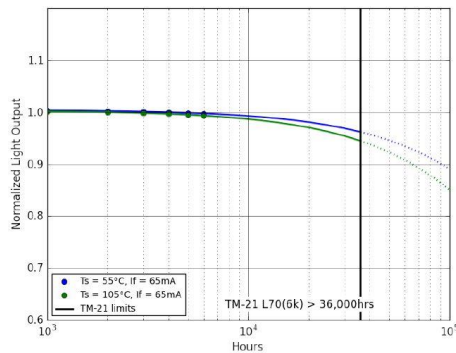

### Lumendrop



### Accessoires

PHB2200-PCC	Reflector prisma 100gr PHB2 200W	
PHB2200-COV	Afschermkap prisma reflector PHB2 200W	
PHB-WBR	Bevestigingsbeugel voor PHB/PHBP	
IP68-connect	Verbindingsset 3-polig IP68 2,5mm² male-female	

### Afmetingen

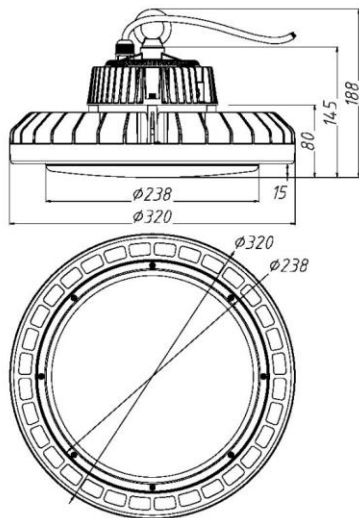

### Aansluitschema



Isolation test 3,75KVac  
TUV, GS, CB, D Mark, C