















Integratech LINEAR TRACK creëert een nieuw idee van railverlichting voor winkelruimten met zijn driver in raildesign. Het superslanke ontwerp zonder zichtbare driver realiseert de perfecte combinatie tussen rail en armatuur. Geschikt voor Global, Eutrac, Staff, Ivela, Unipro, Stucchi en Erco 3-fase rails. Fase- en vermogen selectie met dipswitch. Instelbaar vermogen tussen 20 en



														
IP20	IK06	90	5	tot 150	0,95	50.000 L80B20	JA	90	4000	NEE	SMD2835	25	NEE	JA

Technische eigenschappen

Referentie	LT15614R90
EAN code	5420076264017
ETIM code	EC000986

Elektrische eigenschappen

Systeem vermogen (W)	58
LED vermogen (W)	58
Aansluitspanning (Vac)	220-240
Frequentie (Hz)	50/60
Driver inbegrepen	ja
Driver intern/extern	intern
Driver merk	TOK
Driver type	TK033-60A
Dimbaar	nee
Flicker free	ja
Power factor	0,95
Aansluitkabel	no
Driver output (V)	150-180
Driver output (mA)	95-360
Isolatieklasse	I
Energie klasse	A++
Aantal op 16A C curve	36
Aantal op 16A D curve	
Inrush current driver	33A 250µs

Garantie en certificatie

ENEC	nee
Garantie (jaar)	5 (exclusief batterijen)
TM-21	Lifetime Temp Tc
L80B20	50.000 55°C

Lichttechnische eigenschappen

Lichtbundel(°)	90
Kleurtemperatuur (K)	4000
Kleurweergave CRI	90
UGR	25
Kleurvastheid SDCM	<4
Lumen output (Lm)	8309
Lm/W	150
Flux code	65 93 98 98 100
Ledchip	SMD2835

Ledfabrikant	Edison
Aantal LEDs	165
Fotobiologische klasse	RG0

Afmeting en materiaal eigenschappen

Afmetingen (LxBxH)	1504x64x54mm
Gewicht (kg)	1,5
Kleur	wit RAL9016
Werktemperatuur (°C)	-20~+60
IP waarde	IP20
IK waarde	IK06
UV bestendig	ja
Zeewater bestendig	nee
UL 94	
Aantal in bulk	10
Aantal op pallet	120
Minimum bestelaantal	1
Stockartikel	ja

LT15614R90 - Linear track 1,5m 61W CRI90 4000K 90gr wit

Lumen distribution

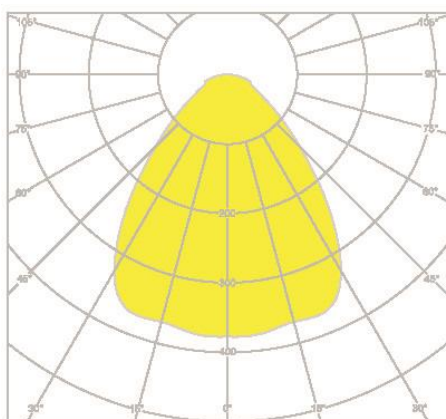

Distance curve:

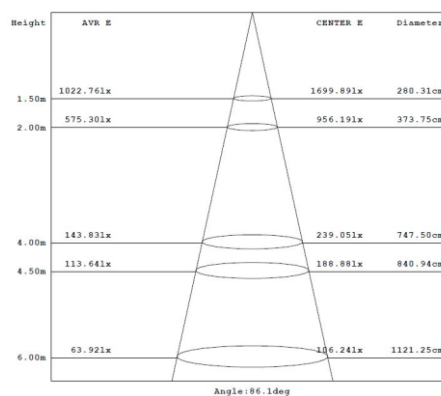

Spectrum distribution

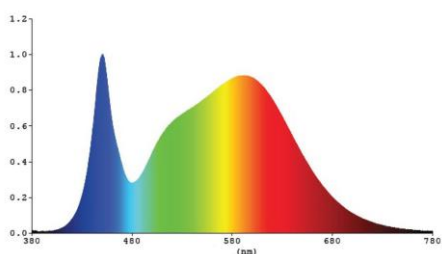

Lumendrop

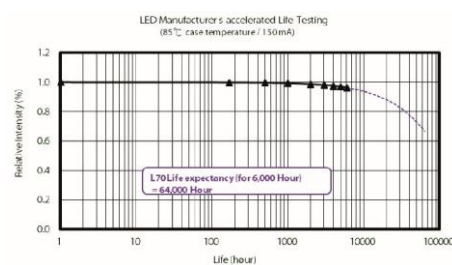

Afmetingen

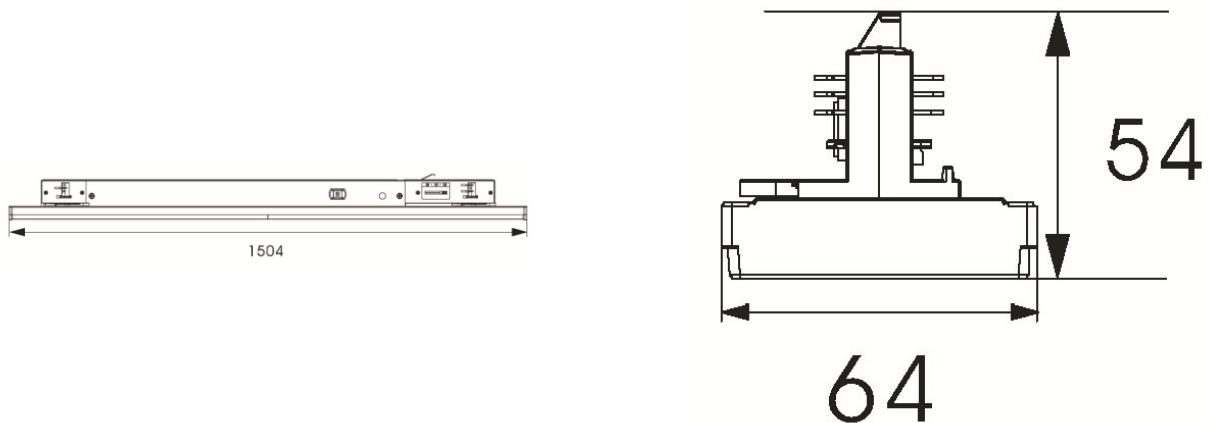

Aansluitschema

