











EV45BDAS4 - Evolve2 45W 4000K asym 2x60gr zwart ENEC

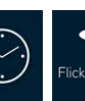

Evolve 2 is de opvolger van de populaire Evolve straler en de referentie onder de led stralers vanwege zijn hoge kwaliteit, duurzaamheid en gebruiksgemak. Evolve 2 is uitgerust met Lumileds SMD3030 chips met een efficiëntie tot 150lm/W bij 4000K en een levensduur L90 >60.000u . De aluminium IP66 behuizing, geschikt voor corrosieve omgevingen en zeezout, is voorzien van een Interpon coating en standaard voorzien van L316 schroeven, een mat veiligheidsglas en een interne 2x60° reflector. De leds worden aangestuurd door een interne dubbel geïsoleerde en flickervrije kwaliteitsdriver. Evolve 2 is aan de achterzijde voorzien van een ruime connectiebox met M20 in- en uitgang en toolless aansluitklemmen. Geen gedoe meer met aparte aftakdozen op de muur. Door de M20 eindstop te vervangen door een extra wartel (ref. EV2M20) is het toestel eveneens geschikt voor doorvoerbedrading! Met de toolless schroeven met richthoek aanduiding kan Evolve 2 eenvoudig gericht worden. Verschillende toebehoren voor grond- of paalmontage zijn beschikbaar alsook verschillende symmetrische/asymmetrische lenzen. 5 jaar garantie. Op aanvraag leverbaar met dimbare driver 1-10V/DALI.

														
IP66	IK08	SYM 2X60G	5	tot 123	0,98	> 60.000 L90	JA	82	4000	NEE	SMD3030	<30	JA	NEE

Technische eigenschappen

Referentie	EV45BDAS4
EAN code	5420076288785
ETIM code	EC001744

Elektrische eigenschappen

Systeem vermogen (W)	40,63
LED vermogen (W)	40,22
Aansluitspanning (Vac)	220-240
Frequentie (Hz)	47-63
Driver inbegrepen	ja
Driver intern/extern	intern
Driver merk	XZ
Driver type	RD CCCB 44
Dimbaar	nee
Flicker free	ja
Power factor	0,98
THD	<10%
Driver output (V)	
Driver output (mA)	
Isolatieklasse	I
Energie klasse	E
Aantal op 16A B curve	24
Aantal op 16A C curve	30
Aantal op 16A D curve	
Inrush current driver	50A 30µs

Garantie en certificatie

ENEC	ja
Garantie (jaar)	5 (exclusief batterijen)

Lichttechnische eigenschappen

Lichtbundel(*)	ASYM 2x60gr
Kleurtemperatuur (K)	4000
Kleurweergave CRI	82
UGR	<30
Kleurvastheid SDCM	3
Lumen output (Lm)	4968
Lm/W	123
Flux code	45 82 98 100 100
Ledchip	SMD3030
Ledfabrikant	Lumileds
Aantal LEDs	60
Fotobiologische klasse	RG1

Afmeting en materiaal eigenschappen

Afmetingen (LxBxH)	244x69x347mm
Gewicht (kg)	2,48
Kleur	zwart
Werktemperatuur (°C)	-30~+45
IP waarde	IP66
IK waarde	IK08
UV bestendig	ja
Zeewater bestendig	ja
UL 94	
Aantal in bulk	4
Aantal op pallet	
Minimum bestelaantal	1
Stockartikel	nee

EV45BDAS4 - Evolve2 45W 4000K asym 2x60gr zwart ENEC

Lumen distribution

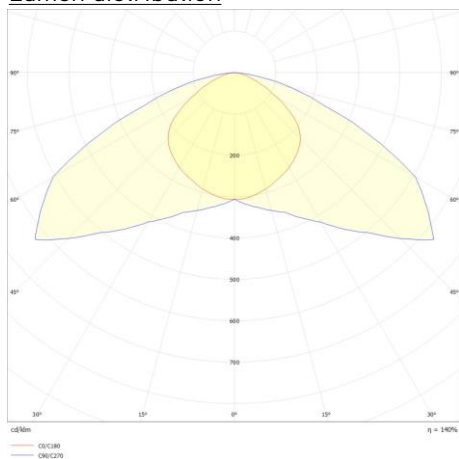

Spectrum distribution

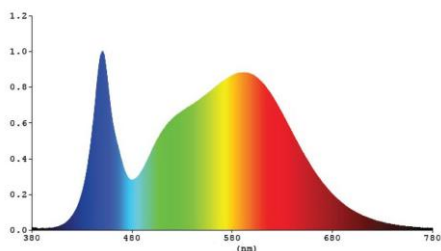

Distance curve:

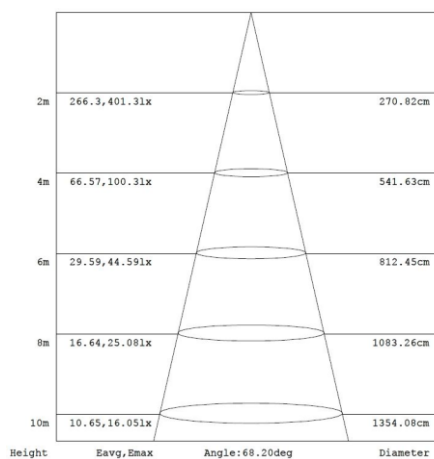

Lumendrop

Model:	EV25B4	EV45B4	EV75B4	EV100B4
Time (t) at which to estimate lumen maintenance (hours):	50000	50000	50000	50000
Lumen maintenance at time (t) (%):	94.72%	94.72%	94.72%	94.72%
Reported L90 (hours):	>60000	>60000	>60000	>60000
Reported L70 (hours):	>60000	>60000	>60000	>60000

Model:	EV150B4	EV200B4	EV240B4	EV240H OB4
Time (t) at which to estimate lumen maintenance (hours):	50000	50000	50000	50000
Lumen maintenance at time (t) (%):	94.72%	94.72%	94.72%	94.72%
Reported L90 (hours):	>60000	>60000	>60000	>60000
Reported L70 (hours):	>60000	>60000	>60000	>60000

EV45BDAS4 - Evolve2 45W 4000K asym 2x60gr zwart ENEC

Afmetingen

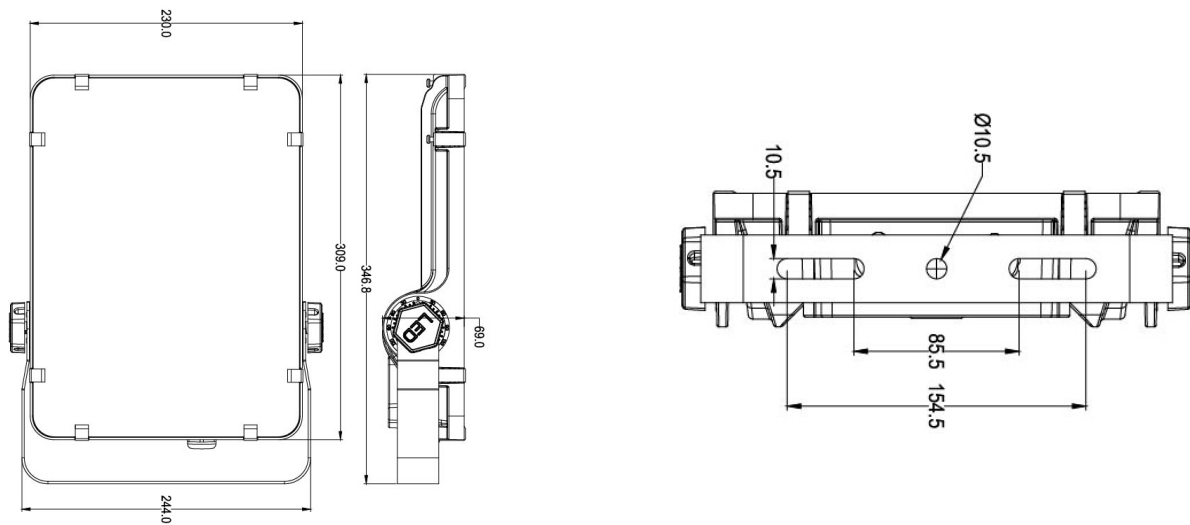

Aansluitschema

